



Adjustment scale

Constant volume flow control CAV controllers

RN-Ex



ATEX certification



Conforms to VDI 6022



For the precise control of constant volume flows in potentially explosive atmospheres (ATEX)

Circular, mechanical self-powered volume flow controllers for the control of supply air or extract air in constant air volume systems, approved and certified for potentially explosive atmospheres (ATEX)

- ATEX-compliant construction
- Approved for gases, mists, vapours and dusts in zones 1, 2, 21 and 22
- Volume flow rate can be set using an external scale, no tools required
- No on-site test measurements required for commissioning
- Suitable for airflow velocities of up to 12 m/s
- Any installation orientation
- Casing air leakage to EN 1751, class C

Optional equipment and accessories

- Acoustic cladding for the reduction of case-radiated noise
- Secondary silencer Type CA for the reduction of air-regenerated noise

General information	2	Order code	8
Function	3	Variants	9
Technical data	4	Dimensions and weight	11
Quick sizing	5	Installation details	13
Specification text	7	Nomenclature	15

General information

Application

- Circular EXCONTROL CAV controllers of Type RN-Ex for the precise supply air or extract air flow control in constant air volume systems
- For use in potentially explosive atmospheres (ATEX)
- Mechanical self-powered volume flow control without external power supply
- Simplified project handling by ordering based on nominal size

Special characteristics

- ATEX mark and certification
- ATEX equipment group II, approved for zones 1, 2, 21 and 22
- The volume flow rate can be set using an external scale; no tools required
- High volume flow rate control accuracy
- Any installation orientation
- Correct operation even under unfavourable upstream or downstream conditions (1.5 D straight section required upstream)

Classification

According to type examination certificate TÜV 05 ATEX 7159 X

- Zone 1 and 2 (substance group gases): II 2 G c II T5 / T6
- Zone 21 and 22 (substance group dusts): II 2 D c II T 80 °C

Nominal sizes

- 80, 100, 125, 160, 200, 250, 315, 400

Variants

- RN-Ex: ATEX volume flow controller in standard construction
- For demanding acoustic requirements
- RN-Ex-D: ATEX volume flow controller with acoustic cladding
 - Acoustic cladding cannot be retrofitted

Construction

- Galvanised sheet steel
- P1: Powder-coated surface, silver (RAL 7001)
- A2: Stainless steel

Parts and characteristics

- Ready-to-commission controller
- Damper blade with low-friction bearings
- Bellows for vibration damping
- Cam plate with leaf spring
- Scale with pointer to set the volume flow rate setpoint
- Terminal point for equipotential bonding
- Enclosed ground cable (approx. 1 m length)
- Aerodynamic functional testing of each unit on a special test rig before shipping

Accessories

- Lip seals on both ends (factory fitted)

Useful additions

- Circular silencers CA (for Germany and Switzerland) and CAH (for EMEA)
- Pipe silencer to be ordered separately

Construction features

- Circular casing
- Construction and materials comply with the EU directive for use in potentially explosive atmospheres (ATEX)
- Spigot suitable for circular ducts to EN 1506 or EN 13180
- Spigot with insert bead for lip seal; (except RN-Ex-P1/80 not possible with insert bead/lip seal)

Materials and surfaces

Galvanised sheet steel construction

- Casing made of galvanised sheet steel
- Interior parts, nominal sizes 80 – 125: stainless steel 1.4301, nominal sizes 160 – 400: galvanised sheet steel
- Polyurethane bellows
- Plain bearings with PTFE coating
- Leaf spring made of stainless steel

Powder-coated (P1)

- Casing made of galvanised sheet steel, powder-coated
- Interior parts, nominal sizes 80 – 125: stainless steel 1.4301, nominal sizes 160 – 400: galvanised sheet steel, powder-coated

Stainless steel construction (A2)

- Casing made of stainless steel 1.4301
- Interior parts made of stainless steel

Variant with acoustic cladding (-D)

- Acoustic cladding made of galvanised sheet steel
- Rubber seal for the insulation of structure-borne noise
- Lining made of mineral wool

Mineral wool

- Acc. to EN 13501, fire rating class A1, non-combustible
- RAL quality mark RAL-GZ 388
- Harmless to health due to high biosolubility, according to TRGS 905 as well as EU Directive 97/69/EC

Standards and guidelines

- Directive 94/9/EC: Equipment and protective systems intended for use in potentially explosive atmospheres
- Meets the hygiene requirements of VDI 6022
- Casing air leakage acc. to EN 1751, class C

Maintenance

- Maintenance-free, as construction and materials are not subject to wear and tear

Function

Functional description

The volume flow controller is a mechanical self-powered unit and works without external power supply. A damper blade with low-friction bearings is adjusted by aerodynamic forces such that the set volume flow rate is maintained within the differential pressure range.

The aerodynamic forces of the airflow create a closing torque on the damper blade. The bellows extends and increases this force while at the same time acting as an oscillation damper. The closing force is countered by a leaf spring that unrolls over a cam plate. The shape of the cam plate is such that a change in the differential pressure leads to an adjustment of the damper blade in a way that the volume flow rate is maintained almost exactly.

Efficient commissioning

The volume flow rate setpoint value can be set quickly and easily using the pointer on the external scale; no measurements are required.

The advantage over flow adjustment dampers is that there is no need for repeat measurements or adjustments by an air conditioning engineer. Should the system pressure change, e.g. by opening or closing of duct sections, the flow rates in the entire system will also change if flow adjustment dampers are used; however, this is not the case with mechanical self-powered volume flow controllers. A mechanical self-powered controller reacts immediately and adjusts the damper blade such that the set constant volume flow rate is maintained.

Schematic illustration of the RN-Ex

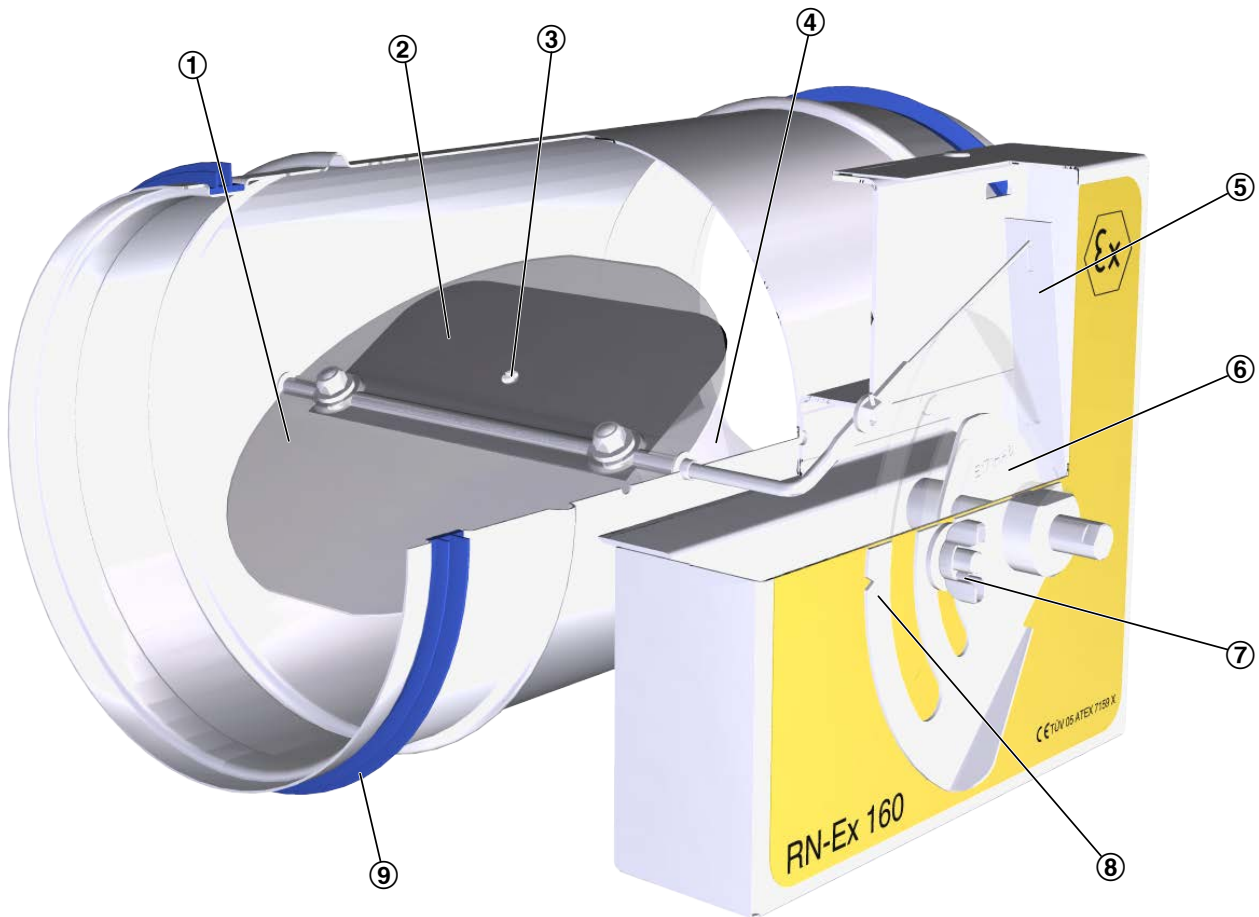

- ① Damper blade
- ② Bellows
- ③ Bellows inlet
- ④ Crossbar
- ⑤ Leaf spring
- ⑥ Cam plate
- ⑦ Volume flow rate scale lock
- ⑧ Volume flow rate scale
- ⑨ Lip seal



Technical data

Nominal sizes	80 – 400 mm
Volume flow rate range	11 – 1400 l/s or 40 – 5040 m ³ /h
Volume flow rate control range	Approx. 25 – 100% of the nominal volume flow rate
Scale accuracy	± 4 %
Minimum differential pressure	50 Pa (nominal size 80: 100 Pa)
Maximum differential pressure	1000 Pa
Operating temperature	10 – 50 °C

Quick sizing

Quick sizing tables provide a good overview of the room sound pressure levels that can be expected. Approximate intermediate values can be interpolated. Precise intermediate values and spectral data can be calculated with our Easy Product Finder design programme.

The first selection criteria for the nominal size are the actual volume flow rates $q_{v,min}$ and $q_{v,max}$. The quick sizing tables are based on generally accepted attenuation levels. If the sound pressure level exceeds the required level, a larger air terminal unit and/or a silencer is required.

Volume flow rate ranges

The minimum differential pressure of CAV controllers is an important factor in designing the ductwork and in rating the fan including speed control. Sufficient duct pressure must be ensured for all operating conditions and for all control units. The measurement points for fan speed control must be selected accordingly.

RN-Ex, volume flow rate ranges and minimum differential pressures

NS	qv [l/s]	qv [m³/h]	①	②	③	④	Δqv [± %]
			Δp _{st min} [Pa]				
80	11	40	100	105	105	105	20
80	20	72	100	105	105	105	15
80	40	144	100	110	115	120	10
80	45	162	100	110	120	125	8
100	22	79	50	55	55	55	10
100	40	144	50	55	55	60	8
100	70	252	50	60	65	70	6
100	90	324	50	60	70	80	5
125	35	126	50	55	55	55	10
125	60	216	50	55	55	55	8
125	115	414	50	60	65	70	6
125	140	504	50	60	70	80	5
160	60	216	50	55	55	55	10
160	105	378	50	55	55	55	8
160	190	684	50	55	60	60	6
160	240	864	50	55	65	70	5
200	90	324	50	55	55	55	10
200	160	576	50	55	55	55	8
200	300	1080	50	55	60	65	6
200	360	1296	50	55	60	65	5
250	145	522	50	55	55	55	10
250	255	918	50	55	55	55	8
250	470	1692	50	55	60	60	6
250	580	2088	50	55	60	65	5
315	230	828	50	55	55	55	10
315	400	1440	50	55	55	55	8
315	750	2700	50	55	60	60	6
315	920	3312	50	55	60	65	5
400	350	1260	50	55	55	55	10
400	610	2196	50	55	55	55	8
400	1130	4068	50	55	55	55	6
400	1400	5040	50	55	55	60	5

① RN-Ex without silencer

② RN-Ex with circular silencer CA or CAH, insulation thickness 50 mm, length 500 mm



③ RN-Ex with circular silencer CA or CAH, insulation thickness 50 mm, length 1000 mm

④ RN-Ex with circular silencer CA or CAH, insulation thickness 50 mm, length 1500 mm

RN-Ex, sound pressure level at differential pressure 150 Pa

NS	qv [l/s]	qv [m³/h]	Air-regenerated noise [dB(A)]				Case-radiated noise [dB(A)]	
			①	②	③	④	①	⑤
			L _{PA}	L _{PA1}			L _{PA2}	L _{PA3}
80	11	40	37	24	17	15	22	<15
80	20	72	39	27	19	17	24	<15
80	40	144	47	34	24	22	31	<15
80	45	162	48	35	25	24	32	<15
100	22	79	37	24	17	15	22	<15
100	40	144	40	47	22	20	21	<15
100	70	252	47	47	27	26	29	<15
100	90	324	50	50	30	29	33	<15
125	35	126	37	27	21	18	15	<15
125	60	216	43	34	27	25	19	<15
125	115	414	50	41	35	33	27	<15
125	140	504	52	44	39	37	30	<15
160	60	216	40	32	26	24	29	<15
160	105	378	45	37	32	29	33	<15
160	190	684	49	41	35	33	39	<15
160	240	864	50	41	36	34	41	16
200	90	324	40	31	24	22	28	<15
200	160	576	43	35	28	26	32	<15
200	300	1080	48	40	33	32	40	17
200	360	1296	49	41	35	33	42	20
250	145	522	41	32	24	22	29	15
250	255	918	42	34	28	26	33	<15
250	470	1692	46	39	33	31	40	19
250	580	2088	48	41	35	34	43	22
315	230	828	39	33	26	23	30	<15
315	400	1440	42	35	29	27	35	<15
315	750	2700	44	38	32	31	40	19
315	920	3312	46	41	35	34	43	23
400	350	1260	46	39	33	29	45	<15
400	610	2196	48	42	36	32	49	18
400	1130	4068	50	44	38	35	54	24
400	1400	5040	51	45	40	37	56	27

① RN-Ex without silencer

② RN-Ex with circular silencer CA or CAH, insulation thickness 50 mm, length 500 mm

③ RN-Ex with circular silencer CA or CAH, insulation thickness 50 mm, length 1000 mm

④ RN-Ex with circular silencer CA or CAH, insulation thickness 50 mm, length 1500 mm

⑤ RN-Ex-D (with acoustic cladding)

Specification text

This tender text describes the general properties of the product. Texts for variants are generated by our Easy Product Finder design programme.

Volume flow controller in round design for constant volume flow systems in potentially explosive atmospheres, mechanically automatic, without auxiliary power, for supply air or extract air, in eight nominal sizes.

Controller ready for commissioning, consisting of the housing with smooth-running control damper, control bellows and external cam disc with leaf spring as well as components for equipotential bonding and explosion protection.

Volume flow controllers are factory-set to a reference volume flow (setting of the desired volume flow on site by the customer). Spigot with insert bead for lip seal, suitable for air ducts to EN 1506 or EN 13180.

Casing air leakage according to EN 1751, class C.

Special characteristics

- ATEX mark and certification
- ATEX equipment group II, approved for zones 1, 2, 21 and 22
- The volume flow rate can be set using an external scale; no tools required
- High volume flow rate control accuracy
- Any installation orientation
- Correct operation even under unfavourable upstream or downstream conditions (1.5 D straight section required upstream)

Materials and surfaces

Galvanised sheet steel construction

- Casing made of galvanised sheet steel
- Interior parts, nominal sizes 80 – 125: stainless steel 1.4301, nominal sizes 160 – 400: galvanised sheet steel
- Polyurethane bellows
- Plain bearings with PTFE coating
- Leaf spring made of stainless steel

Powder-coated (P1)

- Casing made of galvanised sheet steel, powder-coated

- Interior parts, nominal sizes 80 – 125: stainless steel 1.4301, nominal sizes 160 – 400: galvanised sheet steel, powder-coated

Stainless steel construction (A2)

- Casing made of stainless steel 1.4301
- Interior parts made of stainless steel

Variant with acoustic cladding (-D)

- Acoustic cladding made of galvanised sheet steel
- Rubber seal for the insulation of structure-borne noise
- Lining made of mineral wool

Mineral wool

- Acc. to EN 13501, fire rating class A1, non-combustible
- RAL quality mark RAL-GZ 388
- Harmless to health due to high biosolubility, according to TRGS 905 as well as EU Directive 97/69/EC

Construction

- Galvanised sheet steel
- P1: Powder-coated surface, silver (RAL 7001)
- A2: Stainless steel

Technical data

- Nominal sizes: 80 to 400 mm
- Volume flow rate range: 11 – 1400 l/s or 40 – 5040 m³/h
- Volume flow rate control range: approx. 25 – 100 % of the nominal volume flow rate
- Minimum differential pressure: 50 Pa (nominal size 80: 100 Pa)
- Maximum permissible differential pressure: 1000 Pa

Sizing data

- q_v [m³/h]
- Δp_{st} [Pa]

Air-regenerated noise

- L_{PA} [dB(A)]

Radiated noise

- L_{PA} [dB(A)]



Order code

RN-Ex – D – P1 / 160 / D2

1 2 3 4 5

1 Type

RN-Ex Volume flow controller for potentially explosive atmospheres

2 Acoustic cladding

No entry: none

D with acoustic cladding

3 Material

Order example: RN-Ex/160/D2

Nominal size

Material

Accessories

No entry: galvanised sheet steel

P1 Powder-coated RAL 7001 (silver grey)

A2 Stainless steel construction

4 Nominal size [mm]

80, 100, 125, 160, 200, 250, 315, 400

5 Accessories

No entry: without accessories

D2 Double lip seal both ends

160

Galvanised sheet steel

Lip seals on both ends

Variants

RN-Ex

- Volume flow controller for constant air volume flow control in areas with potentially explosive atmospheres (ATEX)
- Spigot

RN-Ex-D

- Volume flow controller with acoustic cladding for constant air volume flow control in areas with potentially explosive atmospheres (ATEX)
- Spigot
- For rooms where the case-radiated noise of the unit is not sufficiently reduced by a false ceiling
- The circular ducts for the room under consideration must have adequate acoustic insulation (provided by others) on the fan and room ends
- Acoustic cladding cannot be retrofitted



Materialien

Order code detail	Part	Material	Notes
-	Casing	Galvanised sheet steel	
	Damper blade	Stainless steel, material no. 1.4301	Nominal size 80
		Stainless steel, material no. 1.4310	Nominal sizes: 100, 125
	Shaft	Galvanised sheet steel	Nominal sizes from 160
		Stainless steel, material no. 1.4301	Nominal sizes 80 to 200
		Stainless steel, material no. 1.4104	Nominal sizes 250 to 400
D	Plain bearings	Steel with PTFE coating	
	Acoustic cladding	Galvanised sheet steel	
	Rubber profile for the insulation of structure-borne noise	Rubber	
	Lining	Mineral wool	
P1	Casing	Galvanised sheet steel	Powder-coated
	Damper blade	Stainless steel, material no. 1.4301	Nominal size 80
		Stainless steel, material no. 1.4310	Nominal sizes: 100, 125
	Shaft	Galvanised sheet steel	Powder-coated, nominal sizes from 160
		Stainless steel, material no. 1.4301	Nominal sizes 80 to 200
		Stainless steel, material no. 1.4305	Nominal sizes 250 to 400
Plain bearings	Bronze with PTFE coating		
A2	Casing	Stainless steel, material no. 1.4301	Nominal size 80
	Damper blade	Stainless steel, material no. 1.4310	Nominal sizes: 100, 125
		Stainless steel, material no. 1.4301	Nominal sizes from 160
	Shaft	Stainless steel, material no. 1.4301	Nominal sizes 80 to 200
		Stainless steel, material no. 1.4305	Nominal sizes 250 to 400
Plain bearings	Bronze with PTFE coating		

Oberflächen

Order code detail	Part	Surface
-	Casing	steel galvanised
P1	Casing	Powder-coated, RAL 7001, silver grey
A2	Casing	Stainless steel construction

Dimensions and weight

RN-Ex

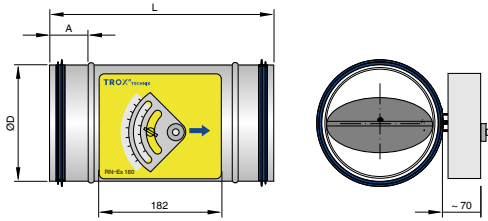

RN-Ex-P1/80

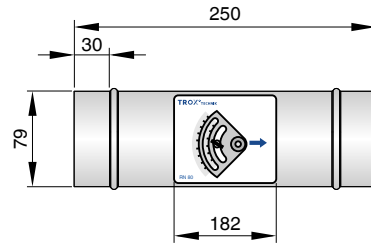

RN-Ex-P1/80/D2

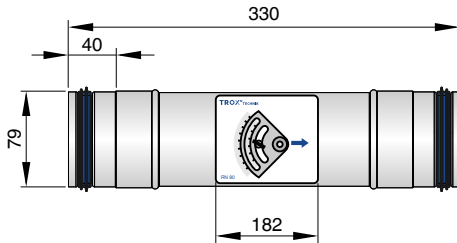

RN-Ex-A2/80

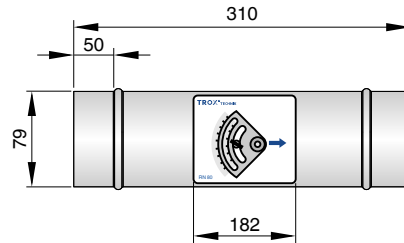

RN-Ex

Nominal size	ØD	L	A	m
	mm			kg
80	79	310	50	1.4
100	99	310	50	1.8
125	124	310	50	2
160	159	310	50	2.5
200	199	310	50	3
250	249	400	50	3.5
315	314	400	50	4.8
400	399	400	50	5.7

RN-Ex-D

RN-Ex-D-P1/80/D2

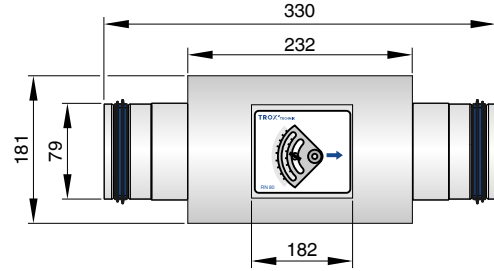
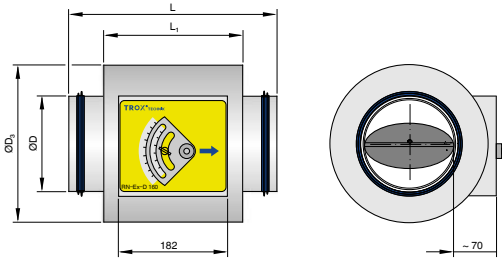

RN-Ex-D-A2/80

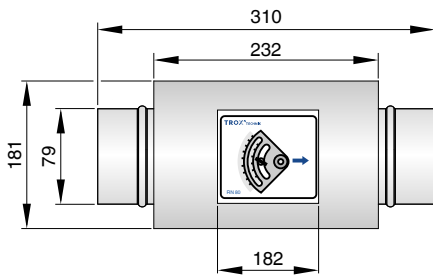

RN-Ex-D

Nominal size	ØD	L	ØD ₃	L ₁	m
	mm				
80	79	310	181	232	2.2
100	99	310	200	232	3.6
125	124	310	220	232	4
160	159	310	262	232	5
200	199	310	300	232	6
250	249	400	356	312	7.3
315	314	400	418	312	9.8
400	399	400	500	312	11.8

Installation details

Installation and commissioning

- Connections for equipotential bonding on the customer side with suitable cables (ground cable approx. 1 m long included in the scope of delivery)
- Any installation orientation
- The volume flow rate can be set using an external scale; no tools required
- No repeat measurements or adjustments by an air conditioning engineer are necessary
- RN-Ex-D: For constructions with acoustic cladding, ducts on the room side should have cladding up to the acoustic cladding of the controller

Upstream conditions

The volume flow rate accuracy ΔV applies to a straight upstream section of the duct. Bends, junctions or a narrowing or widening of the duct cause turbulence that may affect measurement. Duct connections, e.g. branches off the main duct, must comply with EN 1505. Some installation situations require straight duct sections upstream. Free air intake only with a straight duct section of $1D$ upstream.

Bend

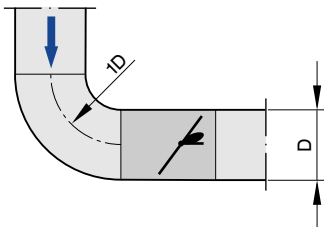

A bend with a curvature radius of at least $1D$ – without an additional straight duct section upstream of the CAV controller – has only a negligible effect on the volume flow rate accuracy.

Junction

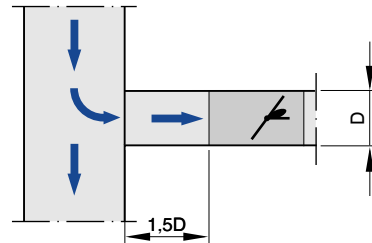

A junction causes strong turbulence. The stated volume flow rate accuracy ΔV can only be achieved with a straight duct section of at least $1.5D$ upstream. Shorter upstream sections require a perforated plate in the branch and before the CAV controller. If there is no straight upstream section at all, the control will not be stable, even with a perforated plate.

Space required for commissioning and maintenance

Sufficient space must be kept clear near any attachments to allow for commissioning and maintenance. It may be necessary to provide sufficiently sized inspection access openings.

Access for commissioning and maintenance

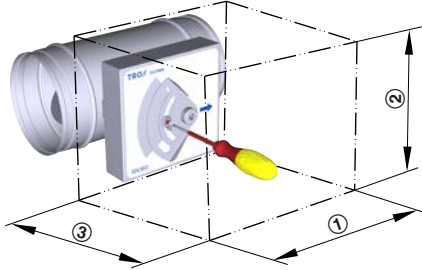

Space required

Standard construction	①	②	③
	mm		
	200	200	200

Nomenclature

$\varnothing D$ [mm]

Outer diameter of the spigot

$\varnothing D_1$ [mm]; [in]

Pitch circle diameter of flanges

$\varnothing D_2$ [mm]; [in]

Outer diameter of flanges

$\varnothing D_4$ [mm]

Inside diameter of the screw holes of flanges

L [mm]; [in]

Length of unit including connecting spigot

L_1 [mm]; [in]

Length of casing or acoustic cladding

H , [mm]; [in]

Screw hole pitch of flange (vertical)

n []

Number of flange screw holes

T [mm]; [in]

Flange thickness

m [kg]

Unit weight including the minimum required attachments for manual adjustment

f_m [Hz]

Octave band centre frequency

L_{PA} [dB(A)]

A-weighted sound pressure level of air-regenerated noise of the CAV controller, system attenuation taken into account

L_{PA1} [dB(A)]

A-weighted sound pressure level of air-regenerated noise of the CAV controller with secondary silencer, system attenuation taken into account

L_{PA2} [dB(A)]

A-weighted sound pressure level of case-regenerated noise of the CAV controller, system attenuation taken into account

L_{PA3} [dB(A)]

A-weighted sound pressure level of case-regenerated noise of the CAV controller with acoustic cladding, system attenuation taken into account

q_{vNom} [m³/h]; [l/s]

Nominal volume flow rate (100 %)

- The value depends on product type and nominal size
- Values are published on the internet and in technical leaflets, and stored in the Easy Product Finder design software.
- Upper limit of the setting range and maximum possible volume flow setpoint of the CAV terminal unit

q_v [m³/h]; [l/s]

Volume flow rate

Δq_v [± %]

Volume flow rate accuracy in relation to the setpoint (tolerance)

Δp_{st} [Pa]

Static differential pressure

$\Delta p_{st min}$ [Pa]

Static minimum differential pressure: The static minimum differential pressure is equal to the pressure loss of the terminal unit when the damper blade is open, caused by flow resistance (damper blade). If the differential pressure on the CAV terminal unit is too low, the set volume flow may not be achieved, not even when the damper blade is open. Important factor for planning the ductwork and for rating the fan including speed control. Sufficient differential pressure must be ensured at all air terminal units for all operating conditions, and that the measurement point(s) for speed control are selected accordingly.

Galvanised sheet steel

- Casing made of galvanised sheet steel
- Parts in contact with the airflow as described for the product type
- External parts, e.g. mounting brackets or covers, are usually made of galvanised sheet steel

Powder-coated surface (P1)

- Casing made of galvanised sheet steel, powder-coated RAL 7001, silver grey
- Parts in contact with the airflow are powder-coated or made of plastic
- Due to production, some parts that come into contact with the airflow may be stainless steel or aluminium, powder-coated
- External parts, e.g. mounting brackets or covers, are usually made of galvanised sheet steel

Stainless steel (A2)

- Casing made of stainless steel 1.4201
- Parts in contact with the airflow are powder-coated or made of stainless steel
- External parts, e.g. mounting brackets or covers, are usually made of galvanised sheet steel