

Volume flow controller -
static transducer

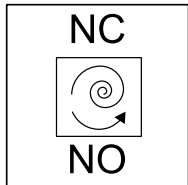

Safe position - spring
return

Control component

XD4



Control component with static transducer and spring return actuator for VAV terminal units

Universal device for use with VAV terminal units

- Controller and static differential pressure transducer in one casing
- Separate actuator with spring return for adjustable safe position
- Use in ventilation and air conditioning systems, with clean and contaminated air
- Simple terminal connection without the use of additional junction boxes
- Suitable for constant and variable volume flow rates
- Activation of override controls via external switch contacts
- Volume flow rates q_{vmin} and q_{vmax} are parameterised in the factory and saved in the controller
- Change of operating parameters via adjustment devices and integrated display
- Service access for manual adjustment devices and PC configuration software
- Integrated display for volume flow rate display, operating mode display and setting of operating parameters

General information	2	Variants	6
Function	3	Technical data	7
Specification text	4	Product details	12
Order code	5	Explanation	15

General information

Application

- All-in-one control devices for VAV terminal units
- Static differential pressure transducer and controller electronics combined in one casing
- Separate actuator with spring return
- Safe position in case of supply voltage failure or wire breakage can be defined in the order code:
NC = damper CLOSED, NO = damper in OPEN position
- For broader range of applications with clean and contaminated air, e.g. in the outlet area with dust and fluff
- Suitable for different control tasks depending on the specification of the setpoint value
- The room temperature controller, central BMS, air quality controller or similar units control the variable volume flow control by specifying setpoint values via analogue signal
- Override controls for activating q_{vmin} , q_{vmax} , shut-off, OPEN position via switch or relay possible
- Volume flow rate actual value is available as linear voltage signal

Control concept

- The volume flow controller works independent of the duct pressure
- Differential pressure fluctuations do not result in permanent volume flow rate changes
- To prevent the control from becoming unstable, a dead band is allowed within which the damper blade does not move.
- Volume flow rate range parameterised in the controller in the factory
 q_{vmin} : minimum volume flow rate
 q_{vmax} : maximum volume flow rate
- Operating parameters are specified via the order code and parameterised in the factory

Operating modes

Variable operation (V)

- Setpoint value setting via analogue interface
- Signal voltage range corresponds to q_{vmin} to q_{vmax}

Constant value mode (F)

- A setpoint signal is not required, setpoint value corresponds to q_{vmin}

Interface

- Analogue interface with adjustable signal voltage range
- Analogue signal for volume flow rate setpoint value
 - Analogue signal for volume flow rate actual value

Signal voltage ranges

- 0 – 10 V DC
- 2 – 10 V DC

Parts and characteristics

- Transducer for static measurement principle
- Overload protection
- Terminal connection for supply line and controls
- Socket plug for the actuator
- Terminals with cover
- Service interface
- Manual actuator adjustment with crank handle
- Raised actuator lockable with crank handle
- Raised actuator unlockable with crank handle

Construction

- GUAC-SM3 with spring return actuator 341C-024-05-V/ST06 for:
- TVR, TZ-Silenzio, TA-Silenzio, TVZ, TVA
 - TVRK up to NW 250
- GUAC-SM3 with spring return actuator 361C-024-20-V/ST06 for:
- TVJ
 - TVT up to dimensions of 1000 x 600
 - TVRK from NW 315

Commissioning

- Due to the volume flow rates set in the factory, always ensure that the control units are only installed in the specified locations
- After successful installation and wiring the controller is ready for use
- Operating parameters can be adjusted by the customer via adjustment device, controller potentiometers including display and PC software

Useful additions

- Adjustment device type GUIV2-A (order code AT-VAV-G)

Function

A closed control circuit for regulation of the volume flow rate, i.e. measuring - comparing - adjusting, is characteristic of air terminal units.

The volume flow rate is determined by measuring a differential pressure (effective pressure). This is done via a differential pressure sensor. An integrated differential pressure transducer converts the effective pressure into a voltage signal. The volume flow rate actual value is hence available as a voltage signal. Due to factory adjustment, 10 V DC always corresponds to the nominal volume flow (q_{vnom}).

The volume flow rate setpoint value is specified by a higher-level controller (e.g. room temperature controller, air quality controller, central BMS). Variable volume flow control results in a value between q_{vmin} and q_{vmax} . It is possible to override the room temperature control, e.g. by a complete shut-off of the duct. The controller compares the volume flow rate setpoint value to the actual value and controls the external actuator accordingly. If the supply voltage is interrupted or the wire breaks, the spring return actuator moves to the fail-safe position OPEN (NO) or CLOSED (NC) as specified in the order code.

Principle of operation Universal controller: TVR, TVJ, TVT, TZ-/TA-Silenzio, TVZ, TVA, TVRK

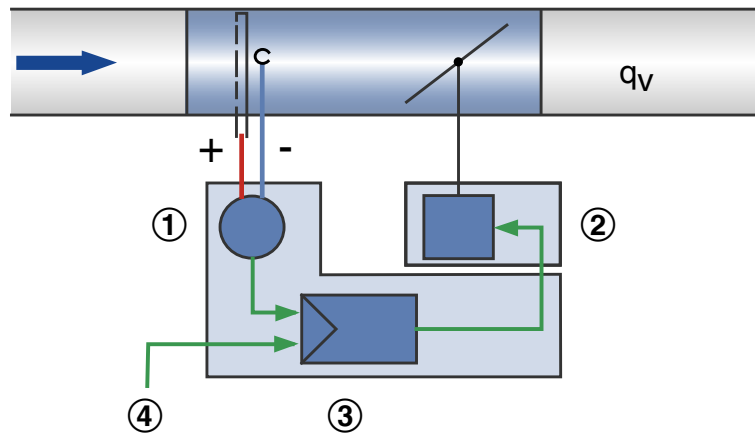

- ① Differential pressure transducer
- ② Actuator

- ③ Volume flow controller
- ④ Setpoint value signal

Specification text

This specification text describes the general properties of the product.

Category

- Universal controller for volume flow rate with safe position

Application

- Regulation of a constant or variable volume flow rate setpoint
- Electronic controller for connecting a reference value and for tapping an actual value signal
- The actual value signal relates to the nominal volume flow rate such that commissioning and subsequent adjustment are simplified
- Stand-alone operation or integration in central building management system

Area of application

- Static transducer for polluted air in ventilation and air conditioning systems

Actuator

- Spring return actuator for defined safe position of the damper blade in case of power failure
- run time max. 150s for 90°; run time spring return <20s for 90

Installation orientation

- either direction

Connection

- Connection terminals

Supply voltage

- 24 V AC/DC

Interface/Control

- Analogue signal 0 – 10 V DC or 2 – 10 V DC

Interface information

- Analogue: Volume flow setpoint and actual value

Special functions

- Display for duct pressure actual value display and parameterisation.
- Activation V_{min} , V_{max} , closed, open by external switch contacts/circuitry

Parameter settings

- Parameters specific to VAV terminal unit parameterised at the factory
- Operating values V_{min} , V_{max} factory parameterised
- Signal characteristic factory parameterised
- Subsequent adjustment directly via control elements and display on the controller or by means of optional tools: adjustment device, PC software (wired in each case)

Factory settings

- Electronic controller factory-mounted on the terminal unit
- Factory parameter settings
- Functional test under air, certified with sticker

Order code

TVR – D / 200 / D2 / XD4 / V 0 / qvmin – qvmax m³/h / NC
 | | | | | | | | | | |
 1 2 5 6 7 8 9 10 11 12

1 Type

TVR VAV terminal unit

2 Acoustic cladding

No entry: none

D With acoustic cladding

3 Material

Galvanised sheet steel (Standard construction)

P1 Powder-coated RAL 7001, silver grey

A2 Stainless steel construction

5 Nominal size [mm]

100, 125, 160, 200, 250, 315, 400

6 Accessories

No entry: none

D2 Double lip seal both sides

G2 Matching flanges for both ends

7 Attachments (control component)

XD4 Universal controller with static transducer

8 Operating mode

F Constant value (a setpoint value)

V variable (setpoint value range)

9 Signal voltage range

0 0 – 10 V DC

2 2 – 10 V DC

10 Operating values for factory setting

Volume flow rates in m³/h or l/s

q_{vconst} (only with operating mode F)

q_{vmin} (only with operating mode V)

q_{vmax} (only with operating mode V)

11 Volume flow unit

m³/h

l/s

12 Damper blade position

NO Power off to OPEN

NC Power off to CLOSE

Order example: TVR/100/D2/XD4/V0/50-354 m³/h/NC

Acoustic cladding

Without

Material

Galvanised sheet steel

Nominal size

100 mm

Accessories

Double lip seal both sides

Attachment

Universal controller, static transducer, spring return actuator

Operating mode

Variable operation – signal voltage range 0 –10 V DC

Volume flow rate

50 – 354 m³/h

Damper blade position

NC Normally CLOSED

Variants

Universal controller XD4, type GUAC-SM3

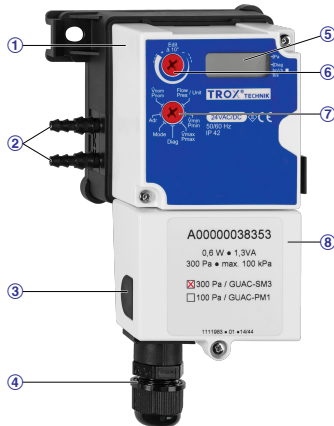

- ① Universal controller
- ② Differential pressure transducer
- ③ Alternative cable access
- ④ Cable gland for supply line
- ⑤ Display
- ⑥ Potentiometers
- ⑦ Selection setting menu
- ⑧ Connections behind removable cover

Universal controller XD4, type GUAC-SM3 (terminal cover opened)

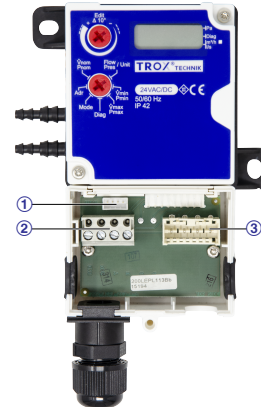

- ① Service connector
- ② Supply voltage and signal lines
- ③ Actuator connection

Actuator with spring return 341C-024-05-V/ST06



- ① Clamping block (drive shaft)
- ② Connecting cable
- ③ Casing actuator
- ④ Plug connection controller
- ⑤ Screw connection

Actuator with spring return 361C-024-20V/ST06



- ① Clamping block (drive shaft)
- ② Connecting cable
- ③ Casing actuator
- ④ Plug connection controller
- ⑤ Screw connection

Technical data

Universal controller for VAV terminal units

-	Controllers		Spring return actuator		-
Order code detail	Part number	Type	Part number	Type	VAV terminal units
XD4	A00000038353	GUAC-SM3	A00000038357	341C-024-05-V/ST06	①
XD4	A00000038353	GUAC-SM3	A00000038355	361C-024-20-V/ST06	②

① TVR, TZ-Silenzio, TA-Silenzio, TVZ, TVA, TVRK up to NW 250

② TVJ, TVT up to dimensions 1000 x 500, TVRK from NW 315

Universal controller XD4, type GUAC-SM3 for VAV terminal units

Universal controller XD4, type GUAC-SM3 for VAV terminal units

Supply voltage	24 V AC $\pm 20\%$, 50/60 Hz
Supply voltage (DC)	24 V DC $\pm 20\%$
Power rating (AC)	1.3 VA plus actuator used *
Power rating (DC)	0.6 W plus actuator used *
Input setpoint value signal or override control	0 – 10 V DC, $R_a > 100 \text{ k}\Omega$ or 2 – 10 V DC, $R_a > 50 \text{ k}\Omega$
Actual value signal output	0 – 10 V DC or 2 – 10 V DC, max. 0,5 mA
IEC protection class	III (protective extra-low voltage)
Protection level	IP 42
EC conformity	EMC to 2014/30/EU
Weight	400 g

* When dimensioning the transformers and the supply cable for the universal controller, the power consumption of the associated actuator must be taken into account.

** Input can be connected to supply voltage as part of override control.

Actuator with spring return 341C-024-05-V/ST06

Actuator with spring return 341C-024-05-V/ST06

Supply voltage	from the controller
Power consumption motor (movement)	5.0 W
Standby power consumption (end position)	2.0 W
Rating	7.5 VA
Torque	5 Nm
Running time for 90°	100 s
Spring return time	< 20 s
Setpoint value signal input	from the controller
IEC protection class	III (protective extra-low voltage)
Protection level	IP 54 (cable entry at the bottom)
EC conformity	EMC to 2014/30/EU
Weight	1.3 kg

Actuator with spring return 361C-024-20-V/ST06

Actuator with spring return 361C-024-20V/ST06

Supply voltage	from the controller
Power consumption motor (movement)	8.0 W
Standby power consumption (end position)	2.0 W
Rating	11.5 VA
Torque	20 Nm
Running time for 90°	150 s
Spring return time	< 20 s
Setpoint value signal input	from the controller
IEC protection class	III (protective extra-low voltage)
Protection level	IP54
EC conformity	EMC to 2014/30/EU
Weight	1.6 kg

XD4, Display



Note: Setting Adr without function

Display range of functions

Display functions

- Volume flow rate actual value (unit optionally m^3/h , l/s)
- Display via 3-character display with position valuation labelling (upstroke symbolises thousands of digits)
- Status and error display for various operating modes, including display of activated override control, display of diagnostic function
- Display of the firmware version

Setting options

- Unit of the volume flow rate display m^3/h or l/s
- Work areas q_{vmin} , q_{vmax}
- Signal voltage range 0 - 10 V or 2 - 10 V DC

Diagnostic function

- Activation of override controls OPEN, CLOSED, q_{vmin} , q_{vmax} , motor stop

Commissioning

- On-site adjusting is not required
- Due to the volume flow rates set in the factory, always ensure that the control units are only installed in the specified locations
- After successful installation and wiring the controller is ready for use
- Comply with the volume flow control range of the volume flow controller, in particular do not fall below the technically minimum volume flow rate
- Only briefly remove the protective cap of the control component during wiring

Product details

Analogue interface 0 – 10 V or 2 – 10 V DC (operating mode V, F)

The analogue interface can be adjusted for the signal voltage range 0 – 10 V DC or 2 – 10 V DC. The assignment of the volume flow rate setpoint value or actual value for voltage signals is shown in the characteristic curves.

- The set signal voltage range is always equally valid for setpoint value and actual value signals.
- The signal voltage range is pre-set in the factory in accordance with the order code entries.
- Signal voltage range can be adjusted on site in the adjustment menu on the display, via adjustment device or PC software.

Setpoint value setting

- In the operating mode V (variable operation), the setpoint value is specified with an analogue signal on terminal Y.
- The selected signal voltage range 0 – 10V or 2 – 10V DC is assigned to the volume flow rate range $q_{vmin} - q_{vmax}$ a change packet.
- Volume flow rate range $q_{vmin} - q_{vmax}$ pre-set in the factory according to the order code entries.
- Subsequent adjustment of q_{vmin} or q_{vmax} on the display, via adjustment device or PC software.
- In the operating mode F (constant value mode), an analogue signal is not required on terminal Y.
- It is controlled by the volume flow rate constant value set by q_{vmin} set volume flow rate constant value regulated.
- Volume flow rate q_{vmin} is pre-set in the factory according to the order code entry.
- Subsequent adjustment of q_{vmin} on the display, via adjustment device or PC software.

Actual value as feedback for monitoring or tracking control

- On terminal U, the actual volume flow rate measured by the controller can be tapped as a voltage signal.
- The selected signal voltage range 0 – 10 V DC or 2 – 10 V DC is shown in the volume flow rate range 0 – q_{vnom} shown.

Override control

For special operating situations, the volume flow controller can be put in a special operating mode (override control). The following are possible: control q_{vmin} , control q_{vmax} , damper blade in the OPEN position or damper blade CLOSED.

Override control via signal input Y

With appropriate wiring on the signal input Y, the override controls can be activated according to the connection diagrams via wiring with external switch contacts/relays. OPEN and CLOSED are only available if the controller is supplied with alternating current (AC).

Override control CLOSED via control signal Y

- With signal voltage range 0 – 10V DC: CLOSED is activated when $q_{vmin} = 0$ is set and the control signal is $Y < 0.5V$ DC.
- With signal voltage range 2 – 10 V DC: CLOSED is activated when control signal is $Y < 0.8$ V DC.
0.8 V = factory setting
- The specified switching point of 0.8 V corresponds here to the factory default setting.

Override control for diagnostic purposes

- For test purposes, the override control can also be activated via the built-in display, a adjustment device or the PC software.

Prioritisation of various setting options

- High priority: specifications via the display, adjustment device or PC software
- Low priority: settings via wiring on the Y signal input of the controller

Spring return actuator

- The spring return function in case of power failure is prepared at the factory according to the order option. NC = damper CLOSED, NO = damper OPEN. This function cannot be set by the customer by parameterisation using service tools.

XD0, Characteristic of the setpoint value signal

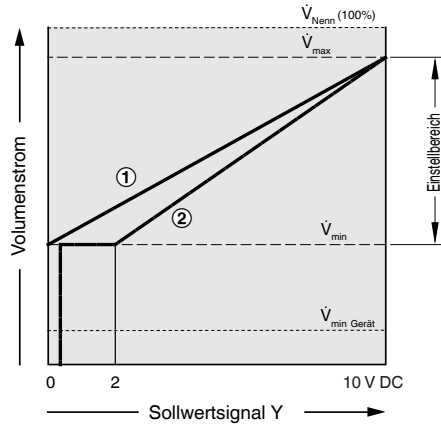

- ① Signal voltage range 0 – 10 V DC
- ② Signal voltage range 2 – 10 V DC

XD0, Characteristic of the actual value signal

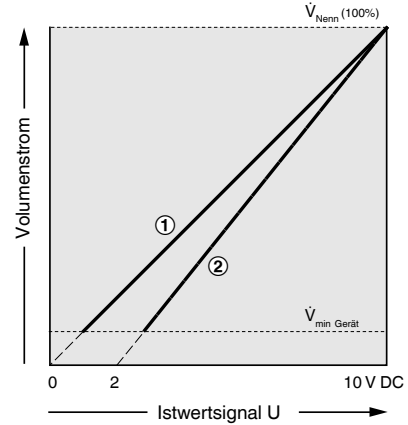

- ① Signal voltage range 0 – 10 V DC
- ② Signal voltage range 2 – 10 V DC

Calculation volume flow rate setpoint value at 0 – 10 V:

0 – 10 V DC

$$\dot{V}_{\text{Soll}} = \frac{Y}{10} (\dot{V}_{\text{max}} - \dot{V}_{\text{min}}) + \dot{V}_{\text{min}}$$

Calculation volume flow rate actual value at 0 – 10 V:

0 – 10 V DC

$$\dot{V}_{\text{Ist}} = \frac{U}{10} \dot{V}_{\text{Nenn}}$$

Calculation volume flow rate setpoint value at 2 – 10 V:

2 – 10 V DC

$$\dot{V}_{\text{Soll}} = \frac{Y-2}{8} (\dot{V}_{\text{max}} - \dot{V}_{\text{min}}) + \dot{V}_{\text{min}}$$

Calculation volume flow rate actual value at 2 – 10 V:

2 – 10 V DC

$$\dot{V}_{\text{Ist}} = \frac{U-2}{8} \dot{V}_{\text{Nenn}}$$

View pluggable terminal strip at GUAC

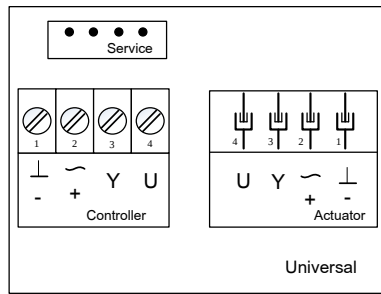

Service: Connection socket for the adjustment device
 Actuator: Connection socket for the actuator
 Controller: power supply and signal lines

Controller:
 1 ⊥, - = Ground, neutral
 2 ~, + = Supply voltage 24 V
 3 Y = setpoint value signal Y and override controls
 4 U/pp = actual value signal U or adjustment device or interface adapter GUIV-S for PC software

Variable volume flow control and override control

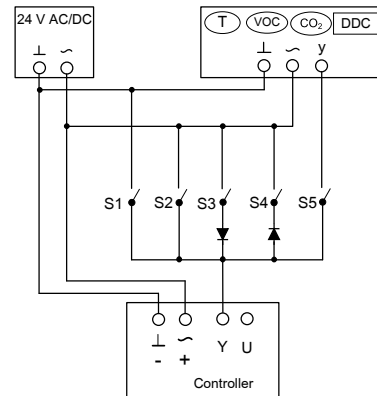

Switching functions

- S1 (0 – 10 V)
 - If $q_{vmin} = 0$ set, then damper CLOSED
 - If $q_{vmin} > 0$ is set, then q_{vmin}
- S1 (2 – 10 V)
 - Damper CLOSED
- S2 Setpoint value setting q_{vmax} activate
- S3 Damper blade OPEN (only with supply voltage 24 V AC)
- S4 Damper blade CLOSED (only with supply voltage 24 V AC)
- S5 Setpoint value setting - variable volume flow via control signal

All switches open (input open): Constant value mode with setpoint value setting q_{vmin}

DDC = Setpoint value setting

When combining several override controls the switches interlock against each other to prevent short circuits
Diode: e.g. 1N 4007

If several controllers are controlled in parallel, observe the basic technical data of the signal output (output current) and the setpoint input (input resistance).

Explanation

q_{vnom} [m³/h]; [l/s]

Nominal volume flow rate (100 %): The value depends on product type and nominal size. Values are published on the internet and in technical leaflets, and stored in the Easy Product Finder design software. Reference value for calculating percentages (e.g. q_{vmax}). Upper limit of the setting range and maximum volume flow rate setpoint value for the VAV terminal unit.

$q_{vmin Unit}$ [m³/h]; [l/s]

Technically possible minimum volume flow rate: The value depends on product type, nominal size and control component (attachment). Values are stored in the Easy Product Finder design software. Lower limit of the setting range and minimum volume flow rate setpoint value for the VAV terminal unit. Depending on the controller, setpoint values below $q_{vmin unit}$ (if q_{vmin} equals zero) may result in unstable control or shut-off.

q_{vmax} [m³/h]; [l/s]

Upper limit of the operating range for the VAV terminal unit that can be set by customers: q_{vmax} can only be smaller than or equal to q_{vnom} . In case of analogue signalling to volume flow controllers (which are typically used), the set maximum value (q_{vmax}) is allocated to the setpoint signal maximum (10 V) (see characteristic).

q_{vmin} [m³/h]; [l/s]

Lower limit of the operating range for the VAV terminal unit that can be set by customers: q_{vmin} should be smaller than or equal to q_{vmax} . Do not set q_{vmin} smaller than $q_{vmin unit}$, otherwise the control may become unstable or the damper blade may close. q_{vmin} may equal zero. In case of analogue signalling to

volume flow controllers (which are typically used), the set minimum value (q_{vmin}) is allocated to the setpoint signal minimum (0 or 2 V) (see characteristic).

q_v [m³/h]; [l/s]

Volume flow rate

Volume flow controller

Consisting of a basic device and an attached control component.

Basic unit

Device for controlling a volume flow rate without an attached control component. The main components are the casing with sensor element(s) to measure the differential pressure and the control damper to throttle the volume flow rate. The basic unit is also referred to as a VAV control unit. Important distinguishing features: - Geometry or unit shape - Material and connection variants - Acoustic characteristics, e.g. acoustic cladding option or integrated silencer - Volume flow rate range

Control component

Electronic unit mounted on the basic device to control the volume flow rate or the duct pressure or the room pressure by adjusting the control damper position. The electronic unit essentially consists of a controller with differential pressure transducer (integrated or external) and an integrated actuator (Easy and Compact controller) or separate actuator (Universal or LABCONTROL controller). Important distinguishing features: - Transducer: dynamic transducer for clean air or static transducer for polluted air - Actuator: standard actuator slow-running, spring return actuator for fail-safe position or fast-running actuator - Interface technology: analogue interface or digital bus interface for connection and tapping of signals and information